

LETTER BLOCK PUZZLE

SOLUTIONS



CHALLENGE 1: 2x3 rectangle



CHALLENGE 2: 3x4 rectangle

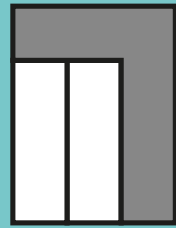

CHALLENGE 3: 4x7 rectangle

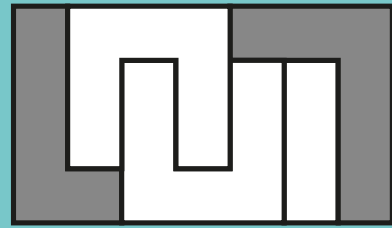

CHALLENGE 4:

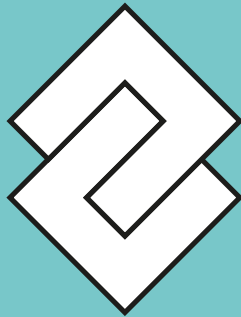

CHALLENGE 5:

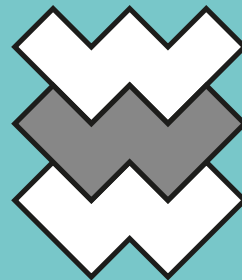

CHALLENGE 6:

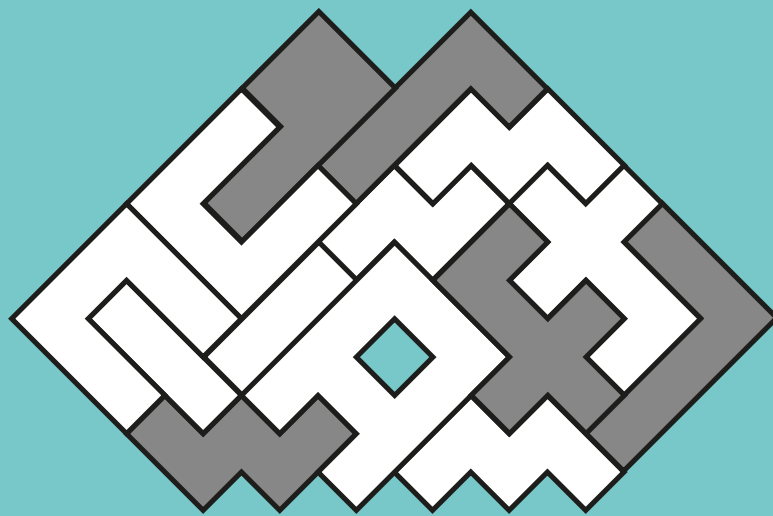

CHALLENGE 7: 2x3x3 cuboid

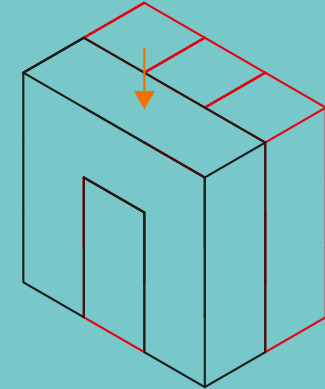
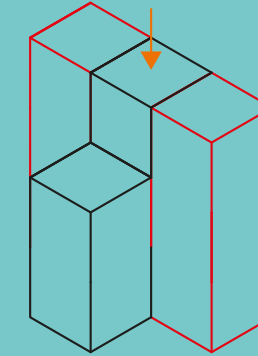
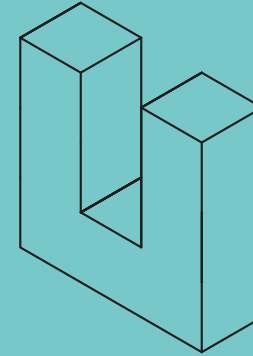
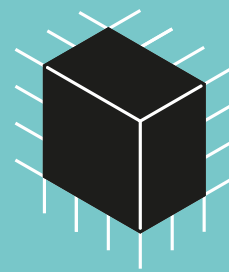

CHALLENGE 8: 2x3x4 cuboid

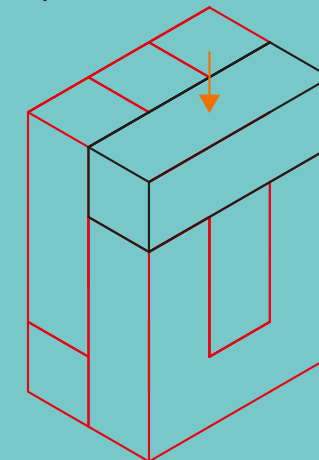
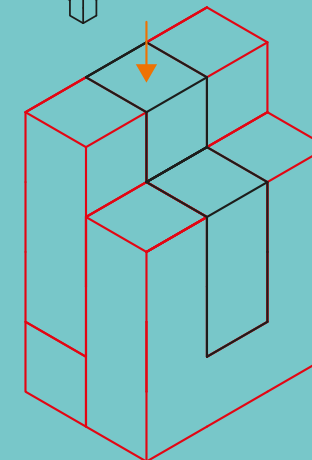
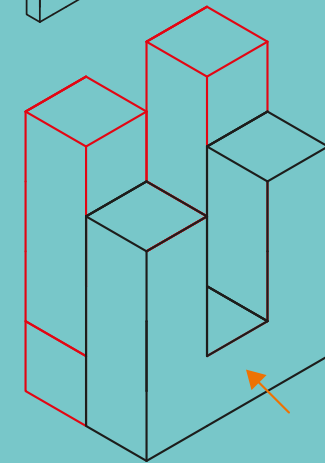
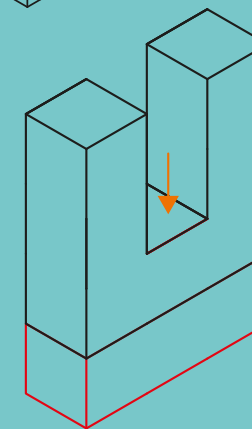
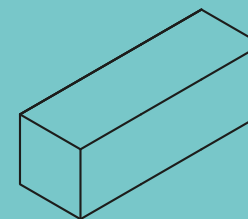

11745 Suitable for 13 years +
Warning! Not suitable for children under 3 years due to small parts which present a choking hazard. Please retain this information for future reference.

Made in China 001-01
Professor Puzzle Ltd., London, TW1 4DP, UK
Professor Puzzle Europe Ltd., Dublin, D22 A370, IRELAND
Professor Puzzle USA, Inc., Chicago, IL 60640, USA
Design Rights and Copyright Professor Puzzle Ltd 2024
www.professorpuzzle.com

ALBERT EINSTEIN™ used with permission of
The Hebrew University of Jerusalem.
By www.CMGWorldwide.com
Puzzle Design by Martin H Watson.

Convient aux enfants de 13 ans et plus.
Attention! Ne convient pas aux enfants de moins de 3 ans à cause des pièces de petite taille qui peuvent présenter un risque d'étouffement. Veuillez conserver ces informations pour vous y référer ultérieurement.
La couleur du contenu peut varier. Fabriqué en Chine.

Adecuado para mayores de 13 años.
¡Advertencia! No apto para niños menores de 3 años debido a las piezas pequeñas que pueden causar riesgos de asfixia. Conserve esta información para futuras consultas.
El color de los contenidos puede variar. Fabricado en China.

Adatto dagli 13 anni in su
Attenzione! Non adatto a bambini sotto i 3 anni a causa di palline che rappresentano un rischio di soffocamento. Conservare queste informazioni per riferimento futuro.
Il colore dei contenuti potrebbe variare. Prodotto in Cina.

Geignet für Kinder ab 13 Jahren.
Achtung! Nicht geeignet für Kinder unter 3 Jahren. Erstickungsgefahr wegen verschluckbarer Kleinteile. Bitte bewahren Sie diese Informationen auf, um später darauf zurückgreifen zu können.
Farbe der Inhalte kann abweichen. Hergestellt in China.

CHALLENGE 9: 4x4x4 cuboid

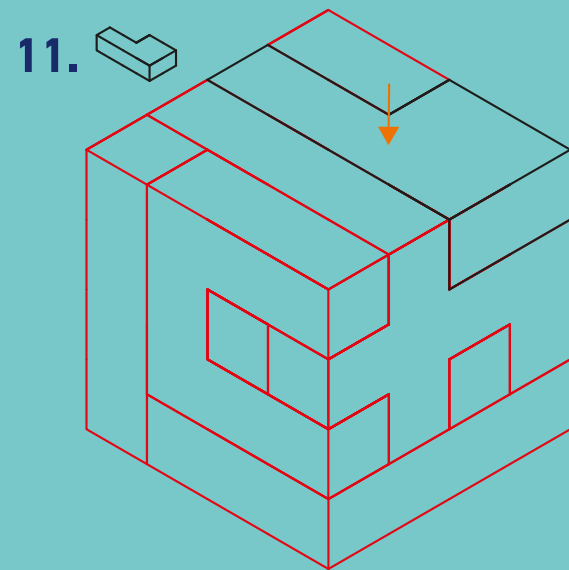
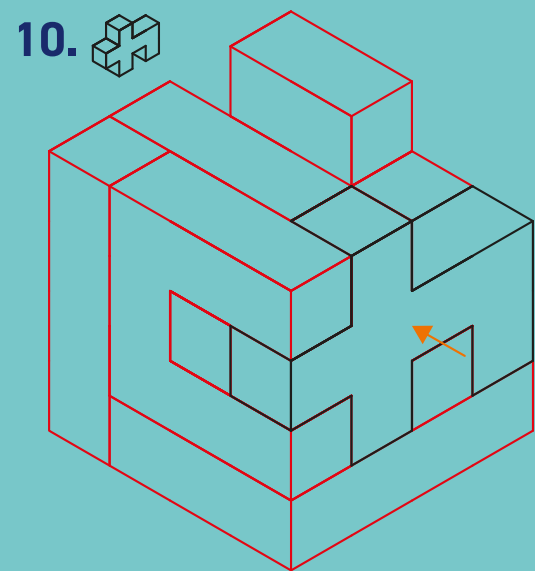
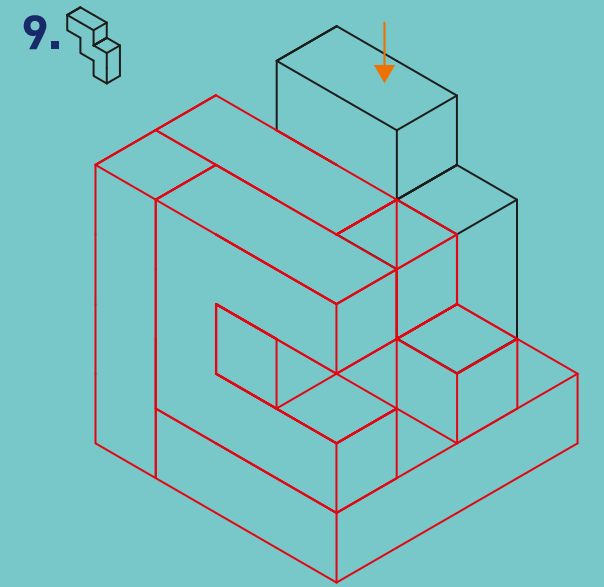
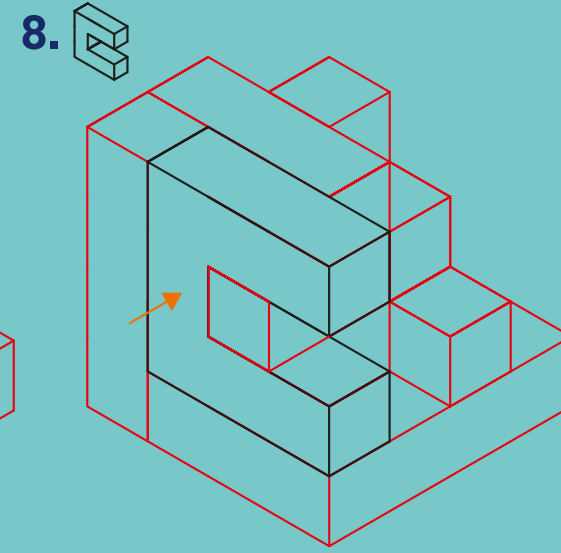
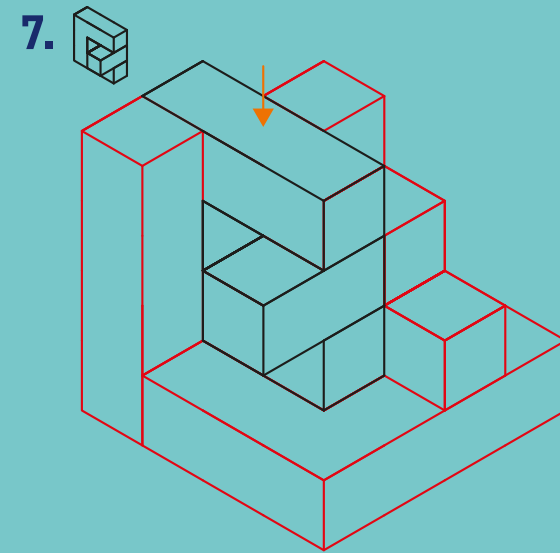
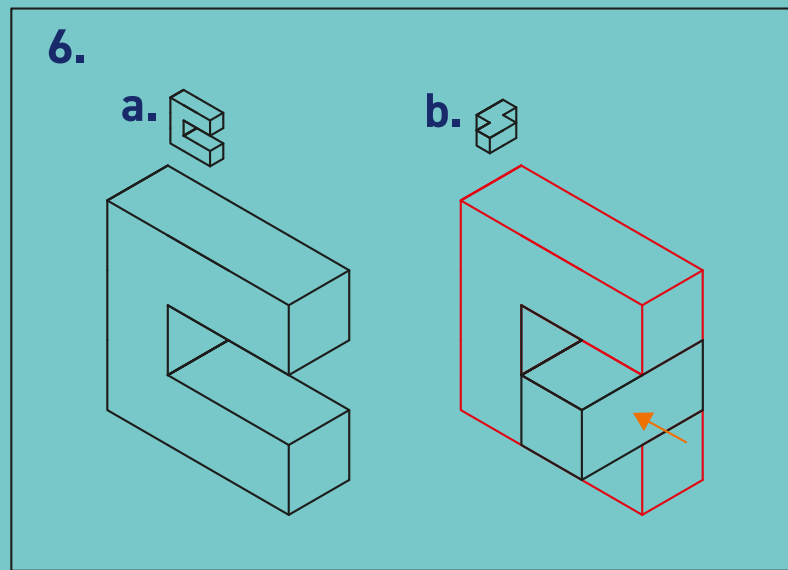
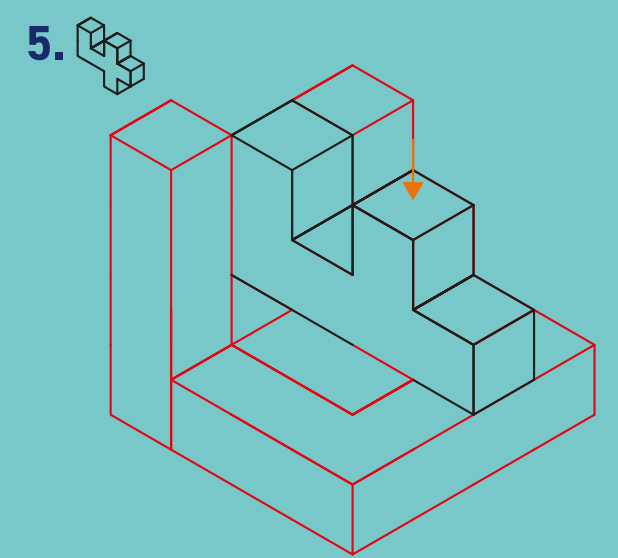
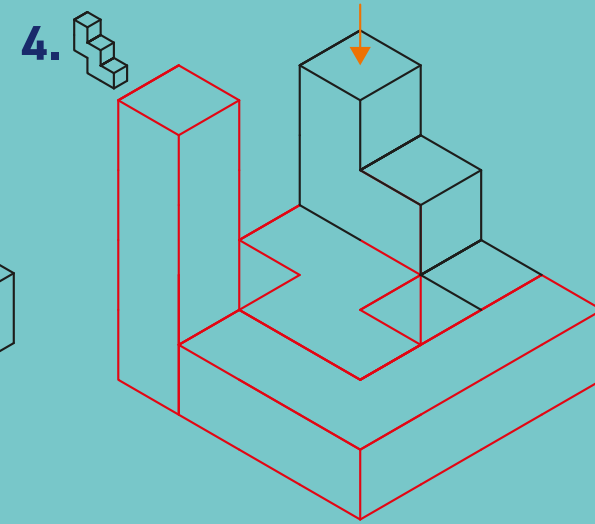
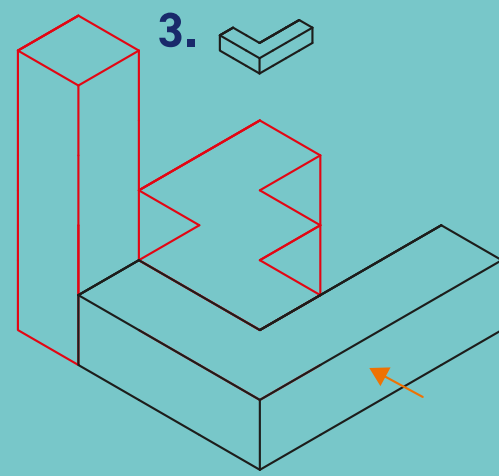
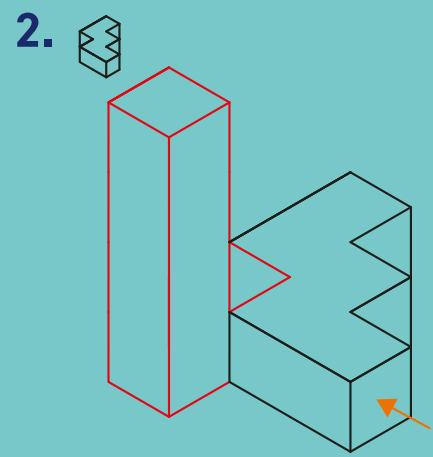
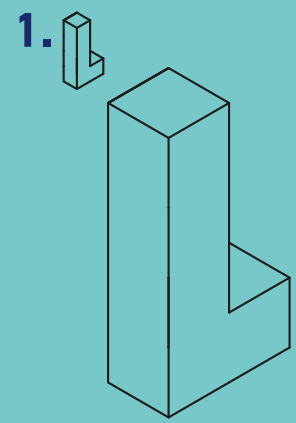

CHALLENGE 10: The Pyramid

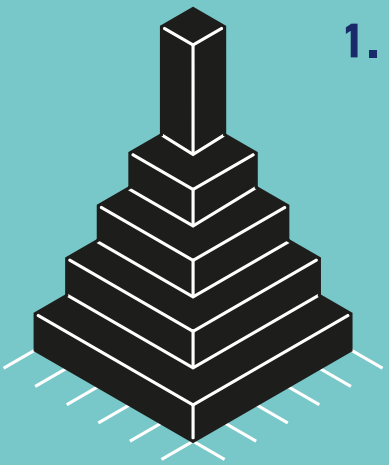

1.

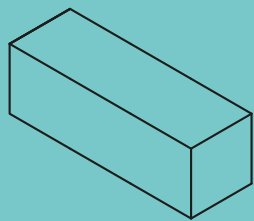

2.

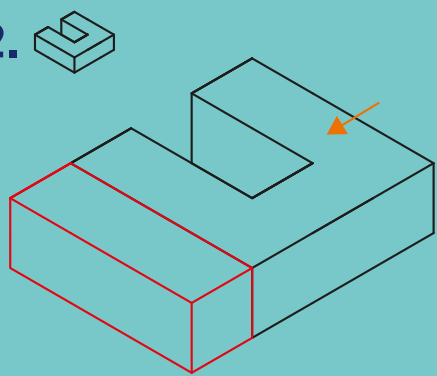

3.

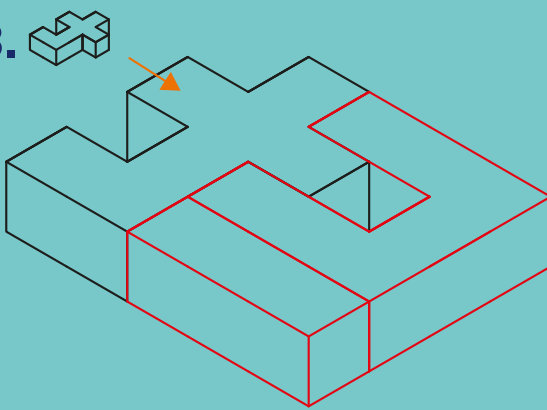

4.

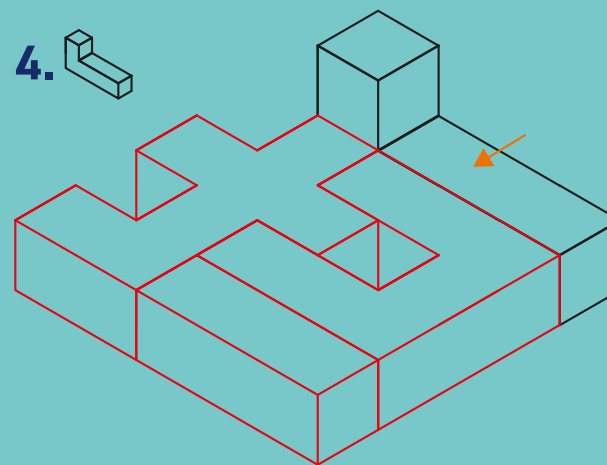

5.

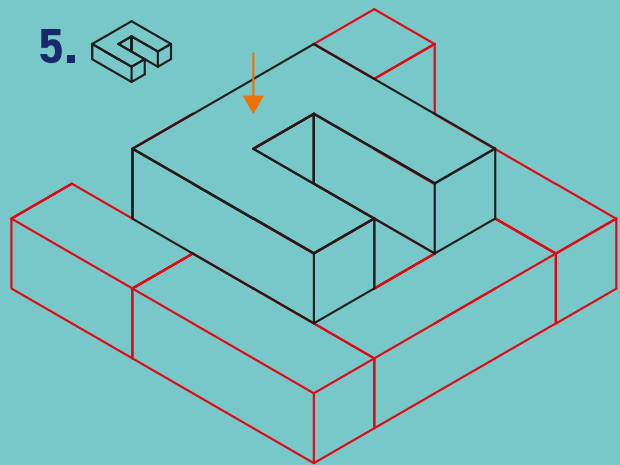

6.

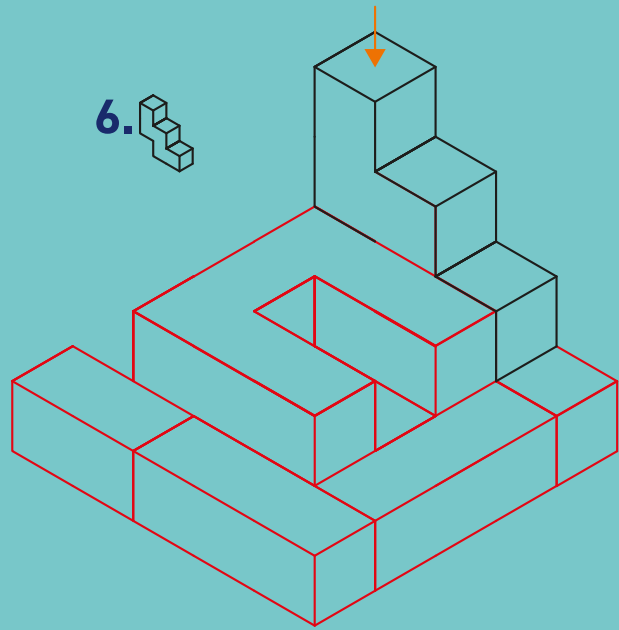

7.

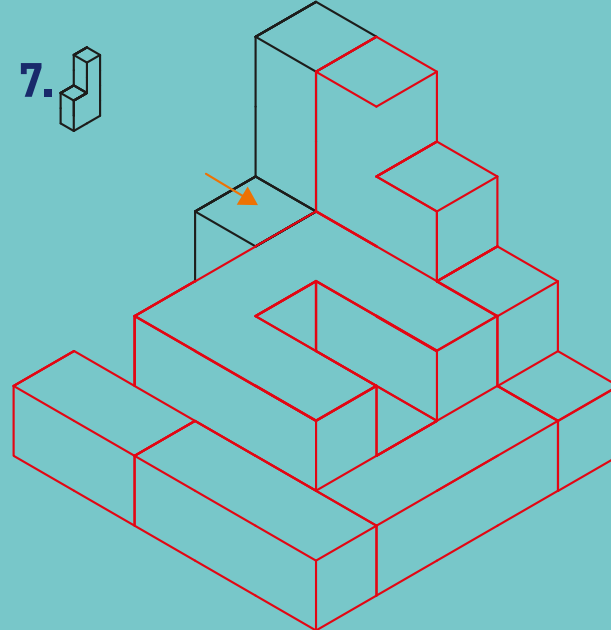

8.

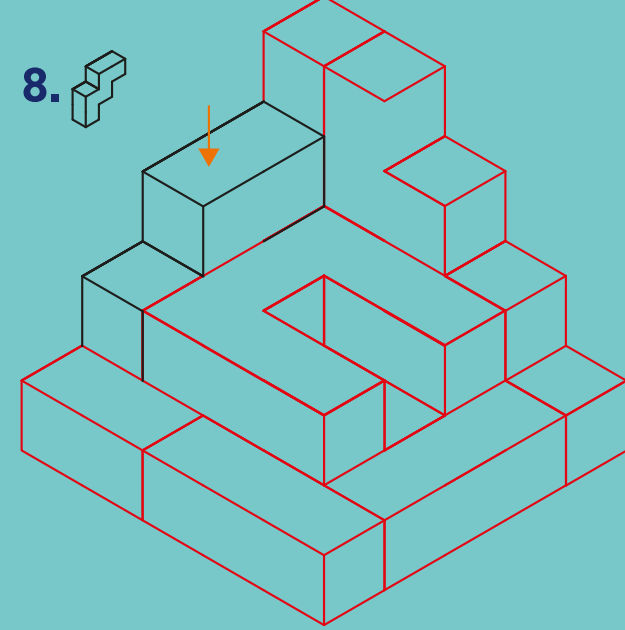

9.

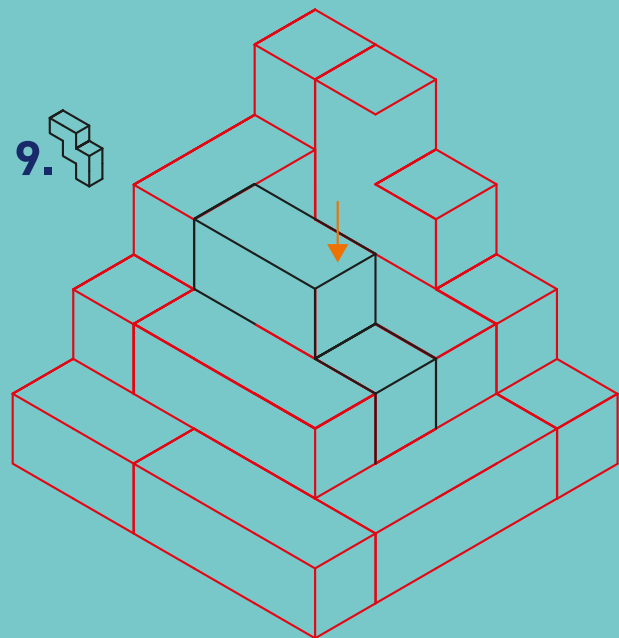

10.

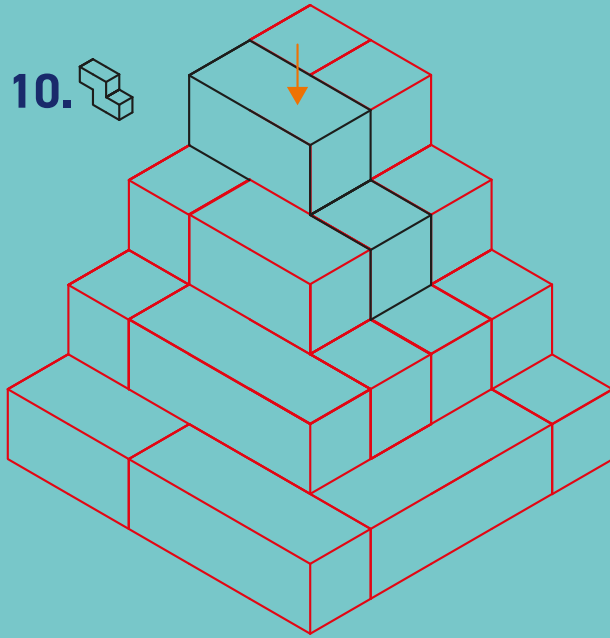

11.

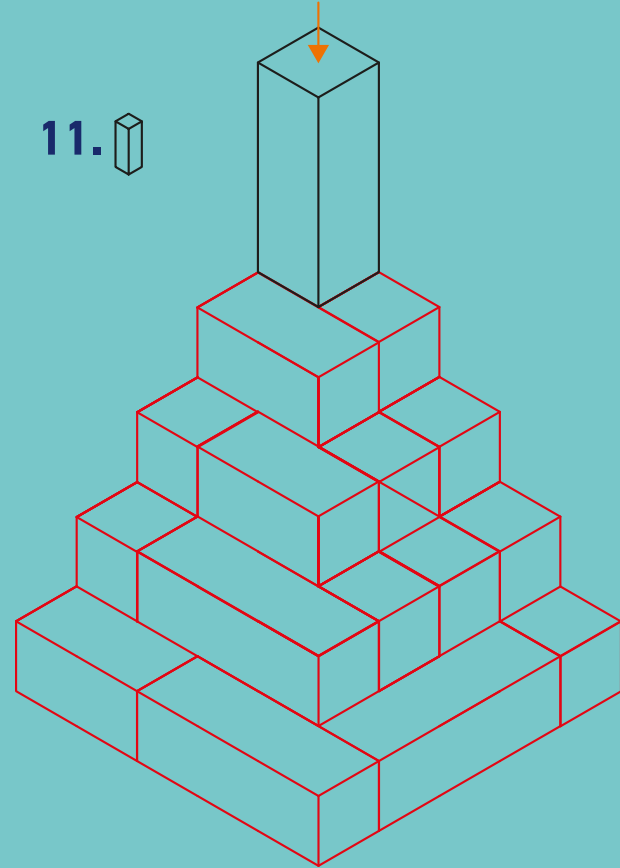

THE QUANTUM QUERY

The hardest of them all!

Use all the letters to make a 4x4x5 cuboid.

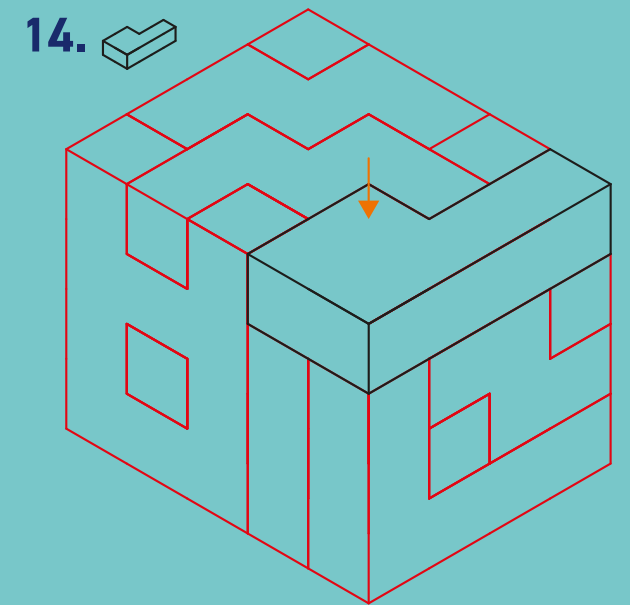
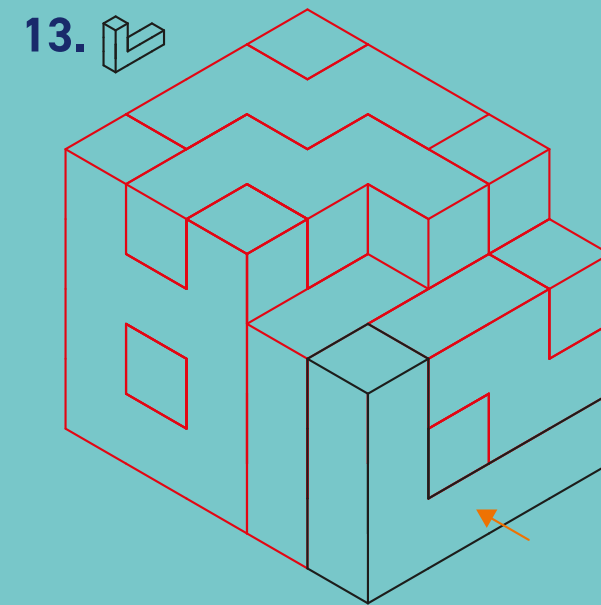
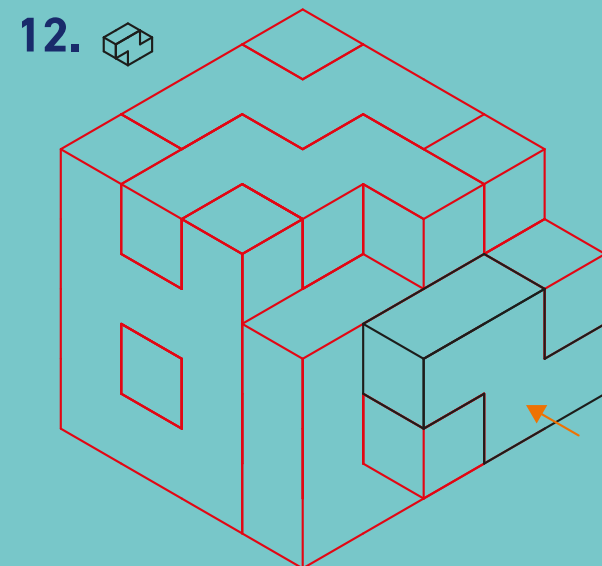
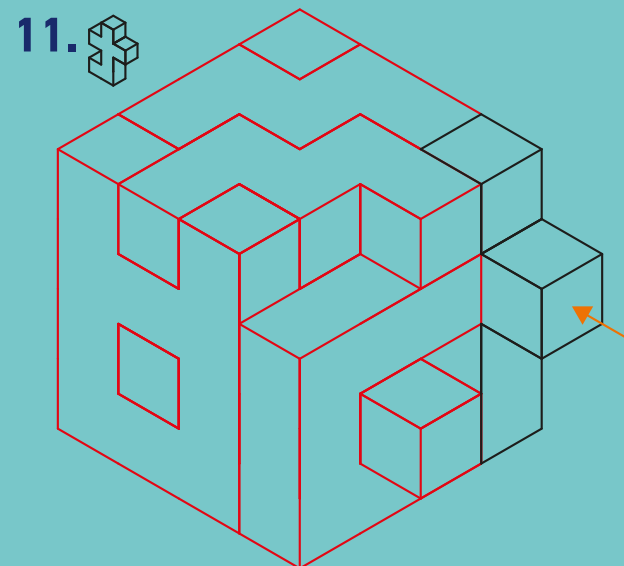
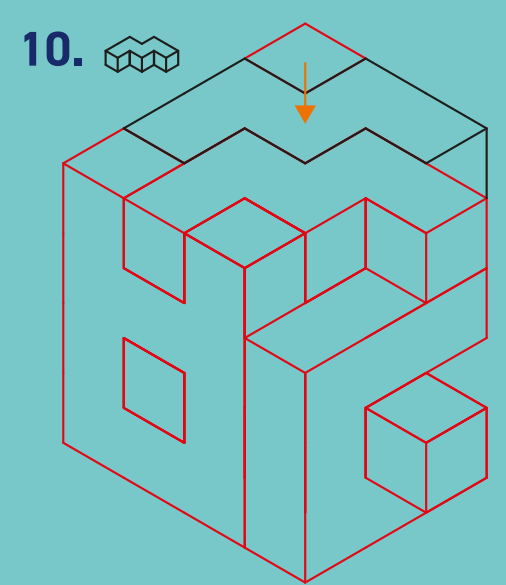
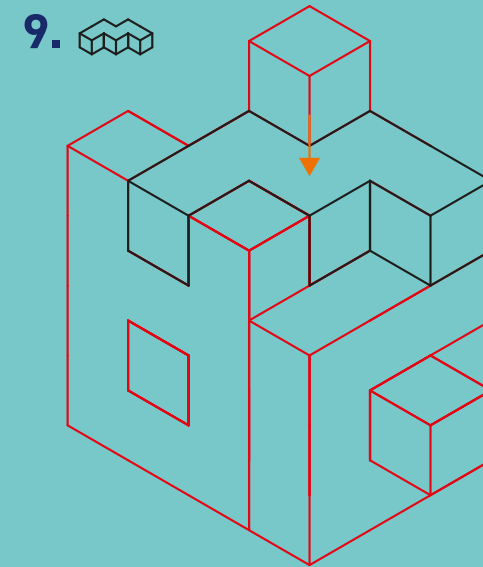
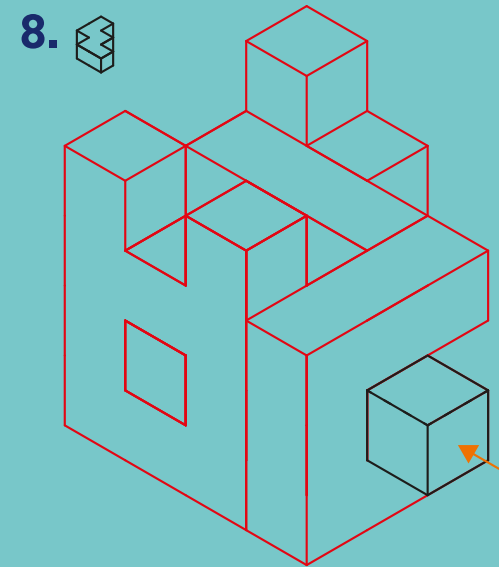
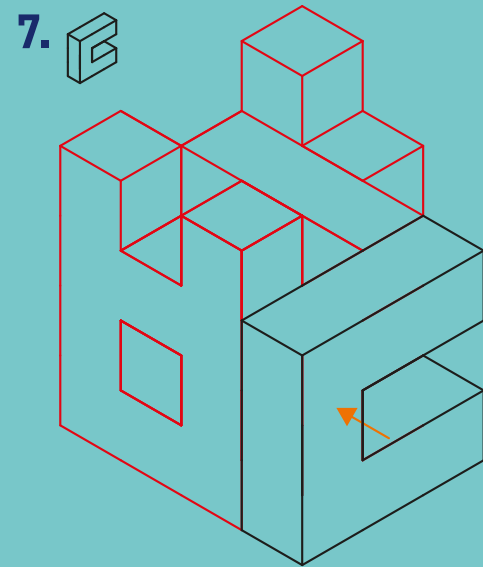
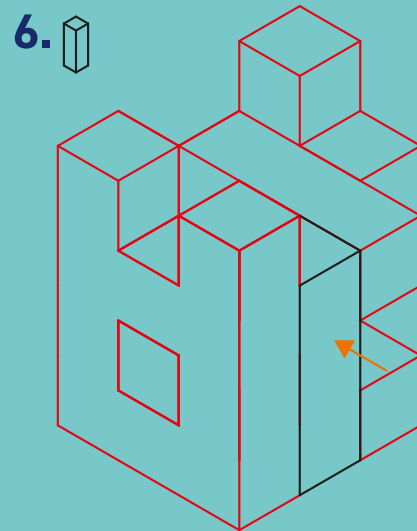
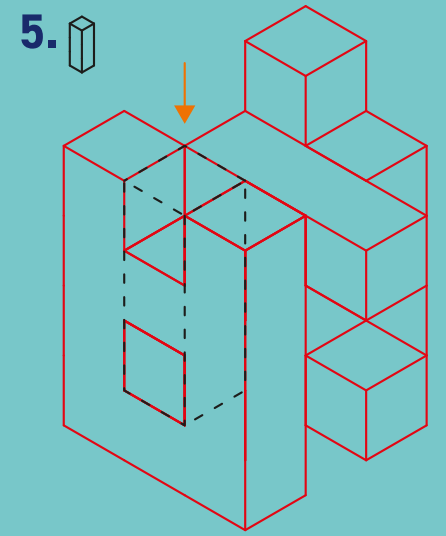
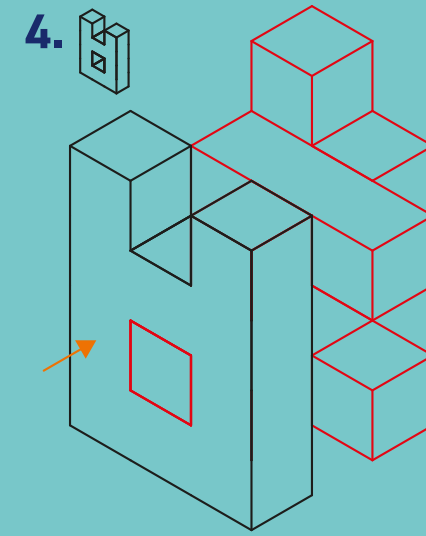
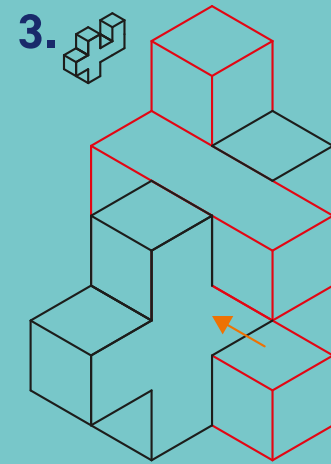
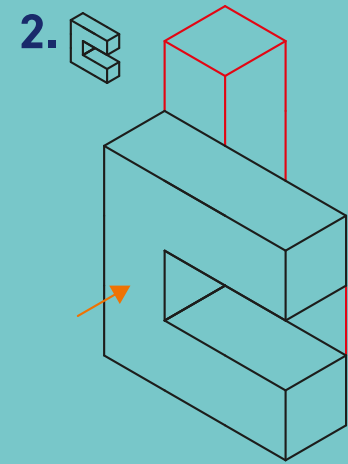
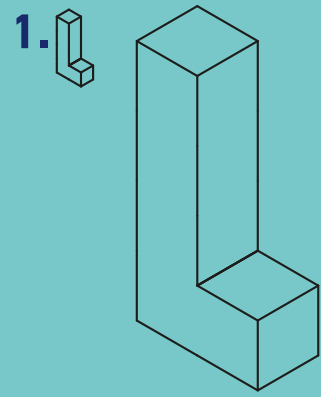

THE RELATIVITY RIDDLE

Using all the letters can you make a square?

Please note that the space in the letter A will obviously remain empty and some letters could be upside-down.

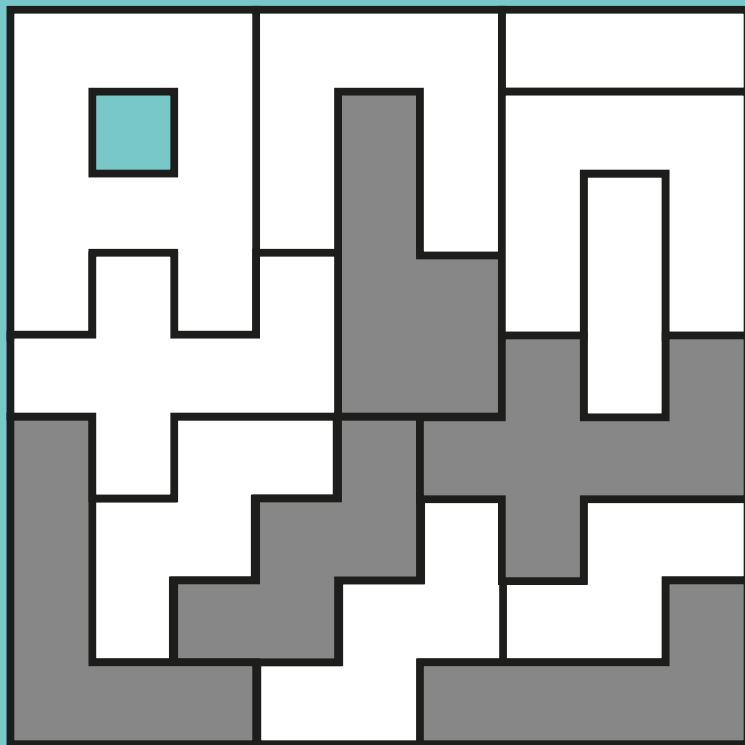
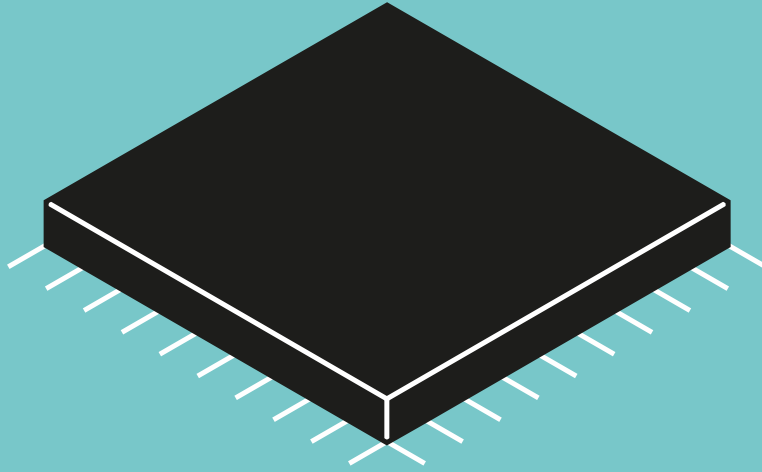

ADDITIONAL CHALLENGES: Can you use some of the letters to create the shapes in the diagrams below?

SQUARES

5x5

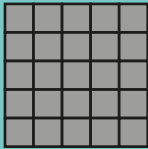

6x6

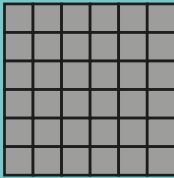

7x7

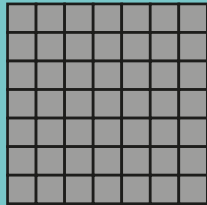

RECTANGLES

3x7

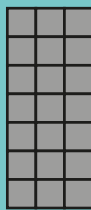

3x8



3x9



3x10



3x11

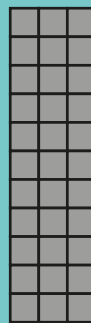

4x5

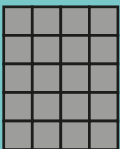

4x6

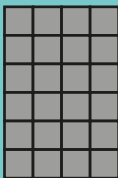

4x7

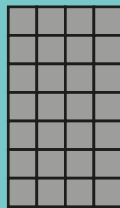

4x8

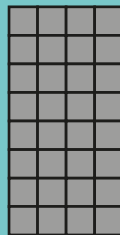

4x9

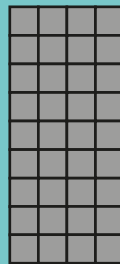

4x10



4x11

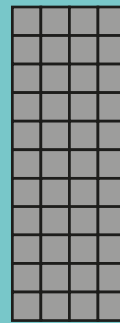

5x6

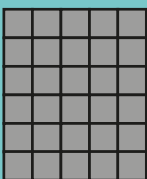

5x7

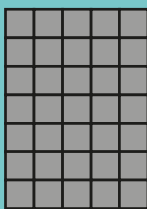

5x8

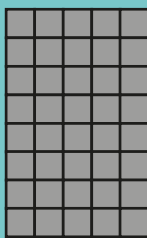

5x9

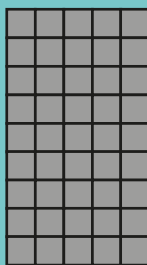

6x7

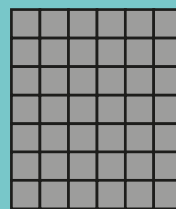

6x8

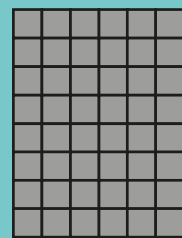

OTHER SHAPES

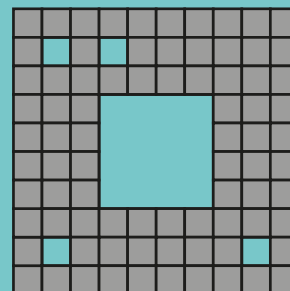
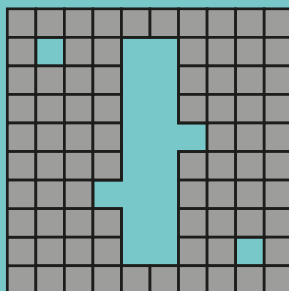
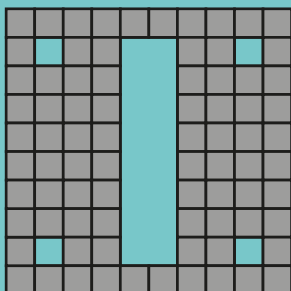

ADDITIONAL CHALLENGES: SOLUTIONS

SQUARES

5x5

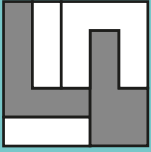

6x6

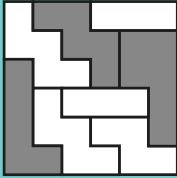

7x7

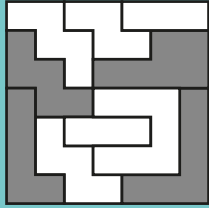

RECTANGLES

3x7



3x8



3x9



3x10



3x11

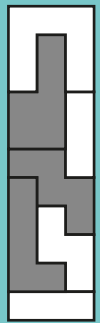

4x5

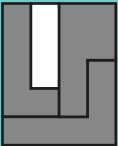

4x6

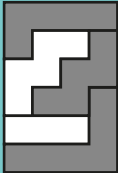

4x7

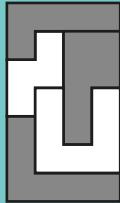

4x8

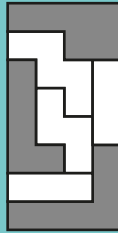

4x9



4x10

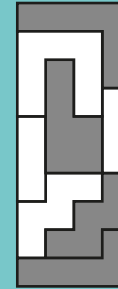

4x11

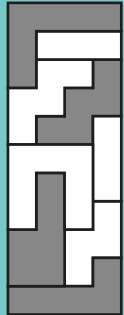

5x6

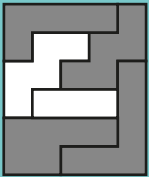

5x7

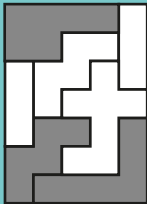

5x8

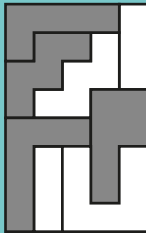

5x9

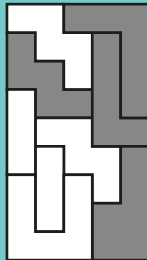

6x7

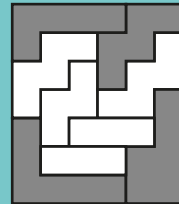

6x8

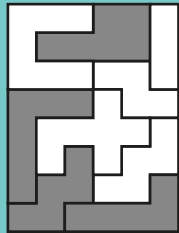

OTHER SHAPES

