

# LETTER BLOCK PUZZLE

## SOLUTIONS



### CHALLENGE 1: 2x3 rectangle



### CHALLENGE 2: 3x4 rectangle

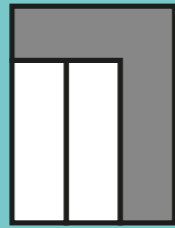

### CHALLENGE 3: 4x7 rectangle

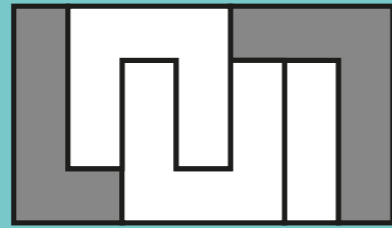

### CHALLENGE 4:

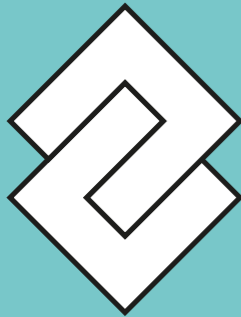

### CHALLENGE 5:



### CHALLENGE 6:

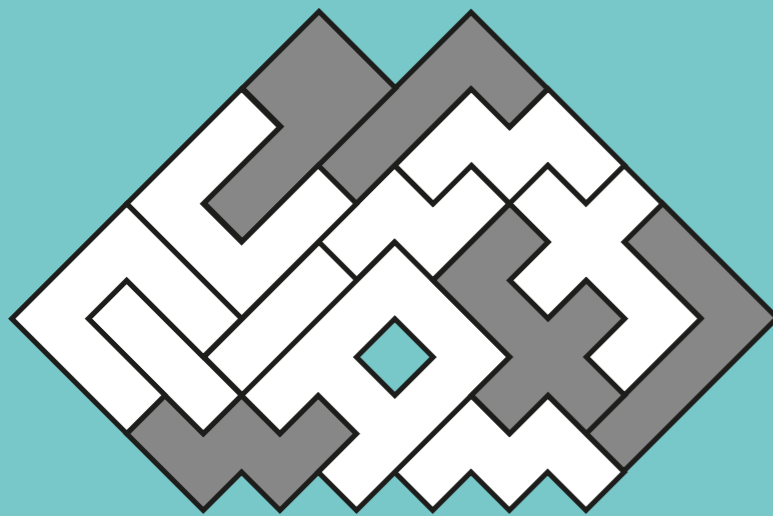

### CHALLENGE 7: 2x3x3 cuboid

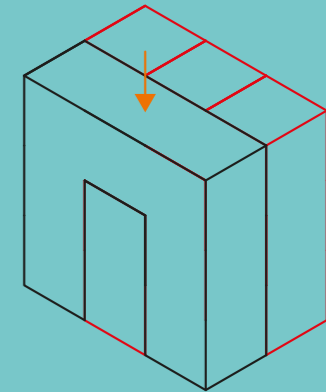
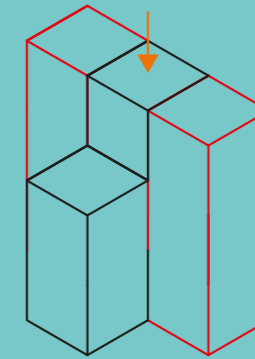
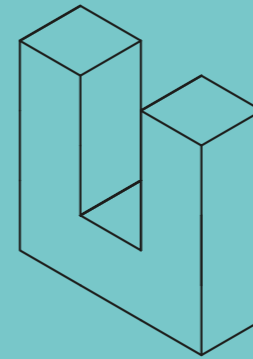

### CHALLENGE 8: 2x3x4 cuboid

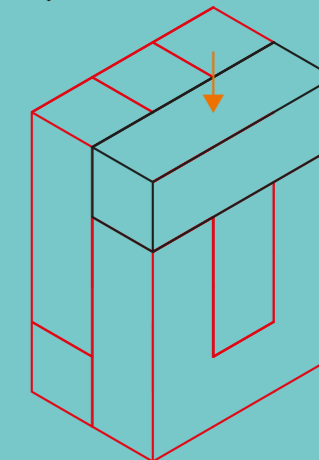
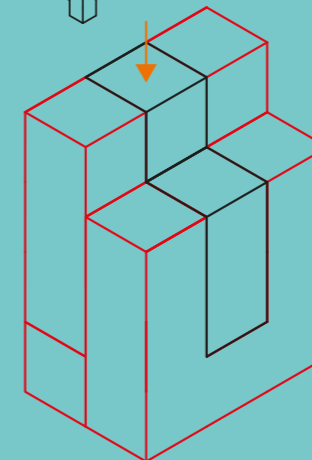
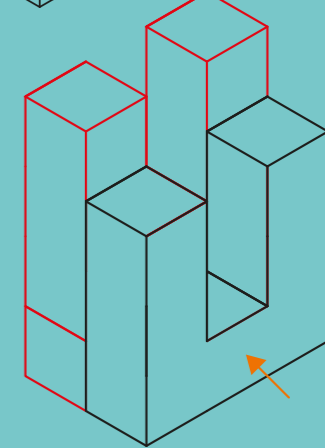
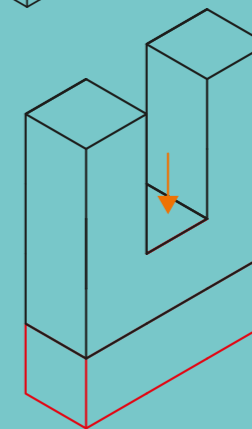
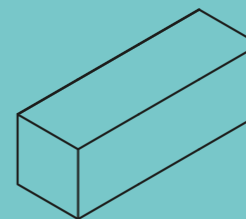

11745 Suitable for 13 years +  
Warning! Not suitable for children under 3 years due to small parts which present a choking hazard. Please retain this information for future reference.

Made in China 001-01  
Professor Puzzle Ltd., London, TW1 4DP, UK  
Professor Puzzle Europe Ltd., Dublin, D22 A370, IRELAND  
Professor Puzzle USA, Inc., Chicago, IL 60640, USA  
Design Rights and Copyright Professor Puzzle Ltd 2024  
www.professorpuzzle.com

ALBERT EINSTEIN and/or EINSTEIN are trademarks or registered trademarks of The Hebrew University of Jerusalem, represented exclusively by BEN Group, Inc. and are used with permission. Official licensed merchandise. All rights reserved.  
Puzzle Design by Martin H Watson.

Convient aux enfants de 13 ans et plus.  
**Attention!** Ne convient pas aux enfants de moins de 3 ans à cause des pièces de petite taille qui peuvent présenter un risque d'étouffement. Veuillez conserver ces informations pour vous y référer ultérieurement.  
La couleur du contenu peut varier. Fabriqué en Chine.

Adecuado para mayores de 13 años.  
**¡Advertencia!** No apto para niños menores de 3 años debido a las piezas pequeñas que pueden causar riesgos de asfixia. Conserve esta información para futuras consultas.  
El color de los contenidos puede variar. Fabricado en China.

Adatto dagli 13 anni in su  
**Attenzione!** Non adatto a bambini sotto i 3 anni a causa di palline che rappresentano un rischio di soffocamento. Conservare queste informazioni per riferimento futuro.  
Il colore dei contenuti potrebbe variare. Prodotto in Cina.

Geignet für Kinder ab 13 Jahren.  
**Achtung!** Nicht geeignet für Kinder unter 3 Jahren. Erstickungsgefahr wegen verschluckbarer Kleinteile. Bitte bewahren Sie diese Informationen auf, um später darauf zurückgreifen zu können.  
Farbe der Inhalte kann abweichen. Hergestellt in China.

# CHALLENGE 9: 4x4x4 cuboid

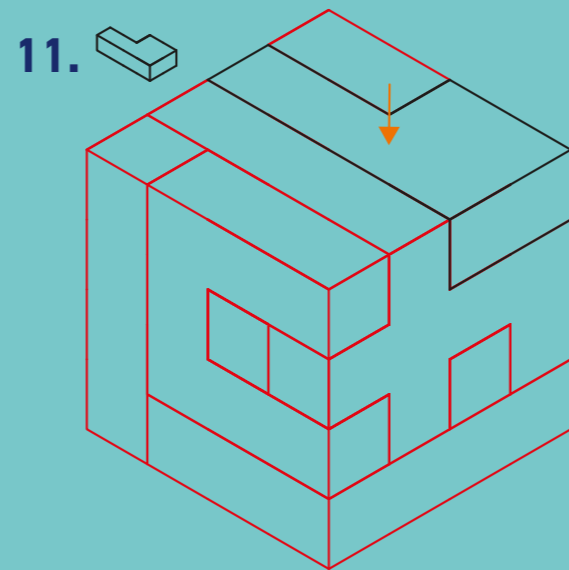
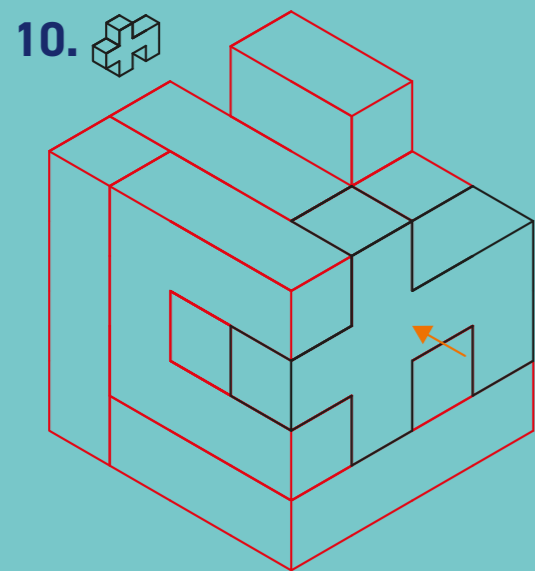
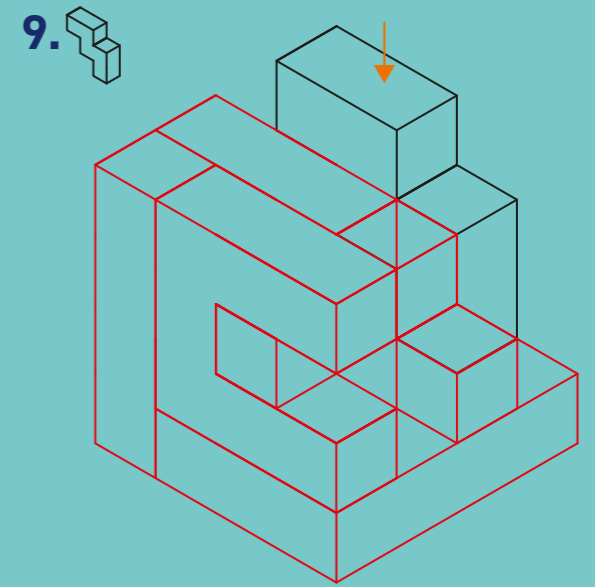
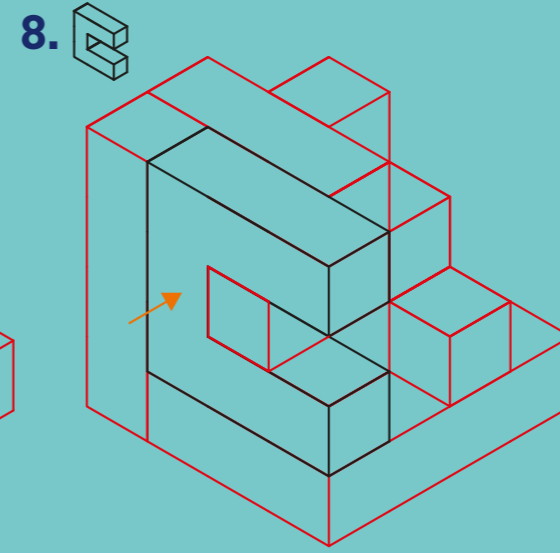
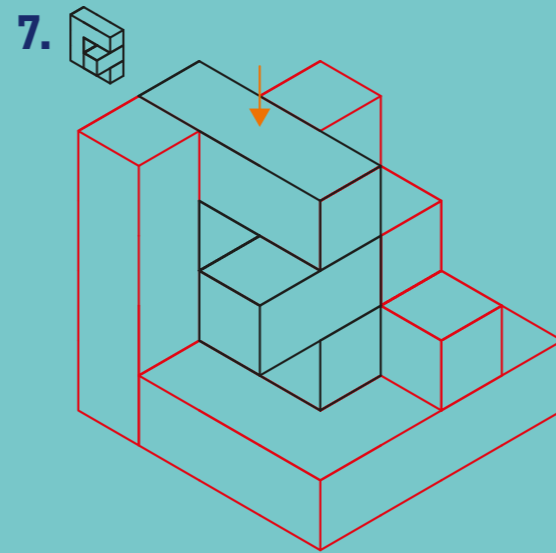
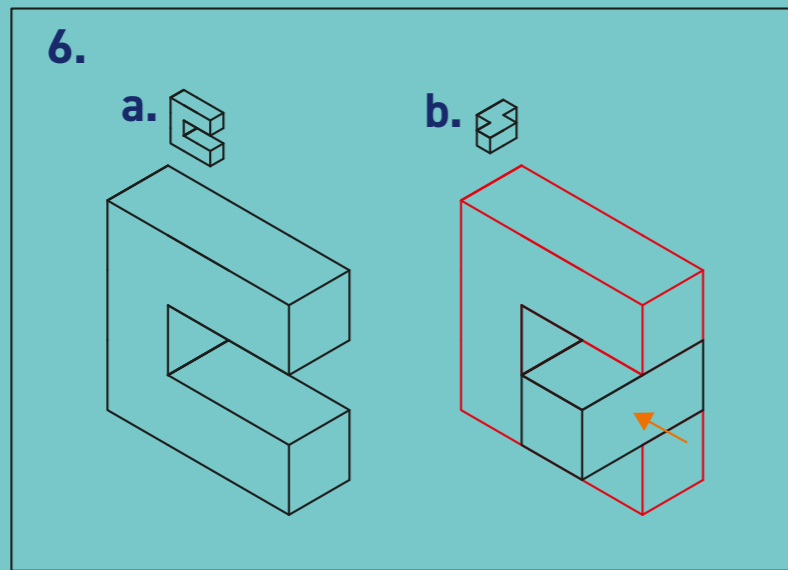
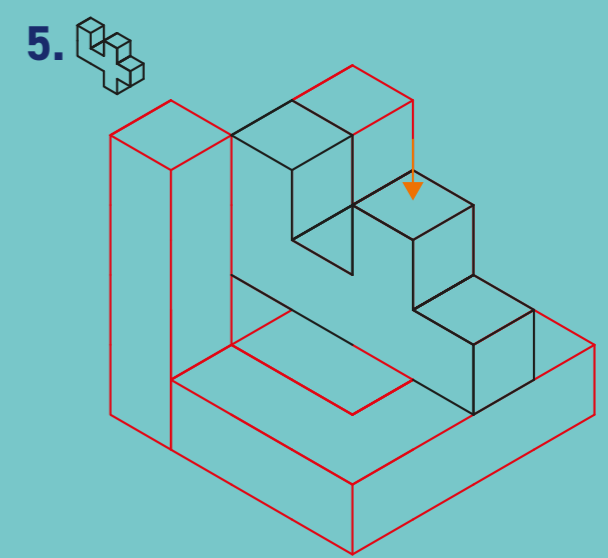
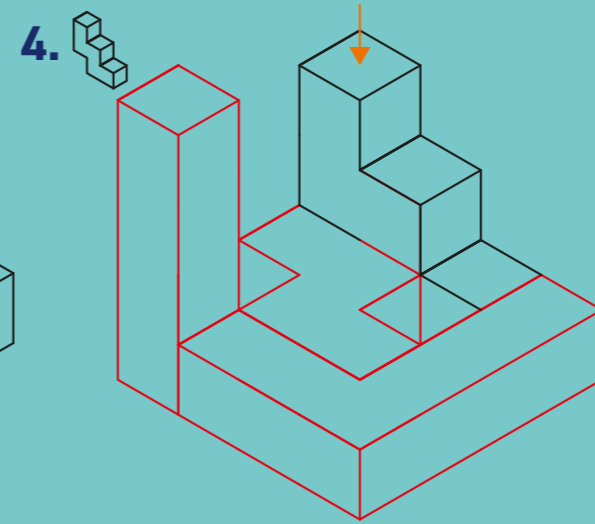
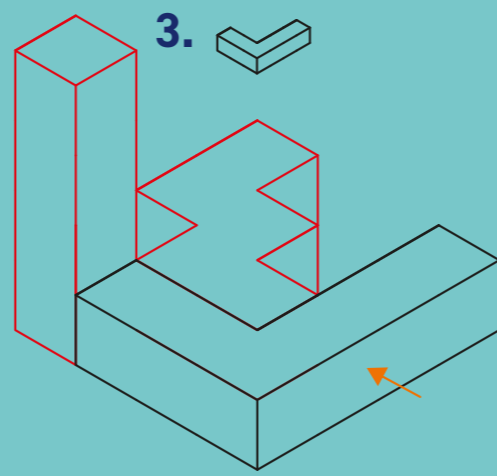
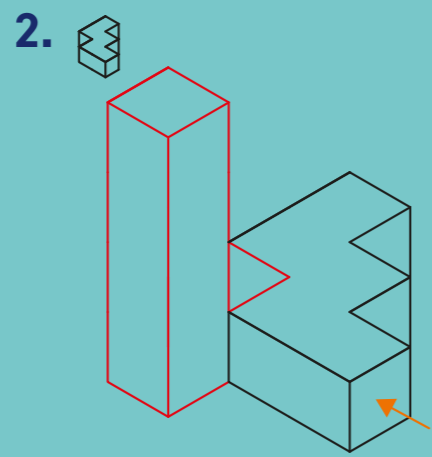
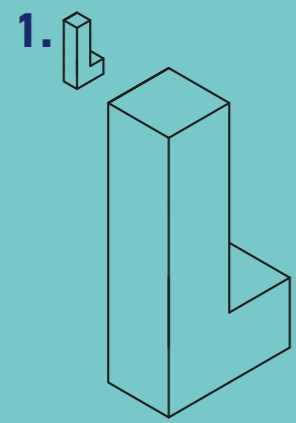

CHALLENGE 10: The Pyramid

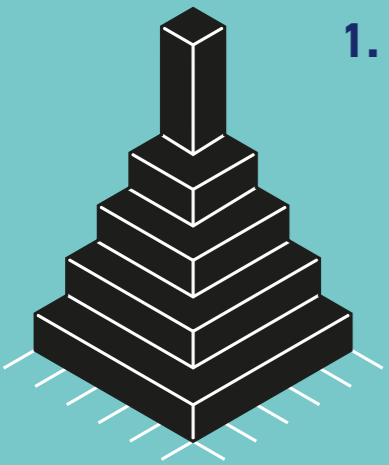

1.

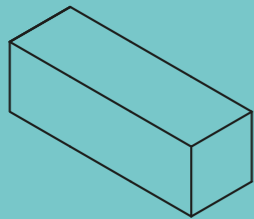

2.

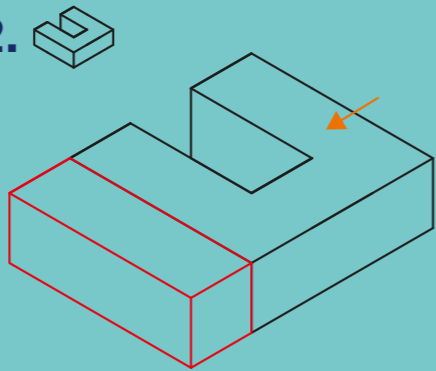

3.

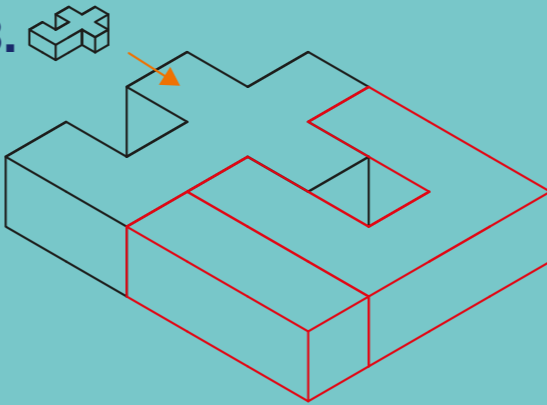

4.

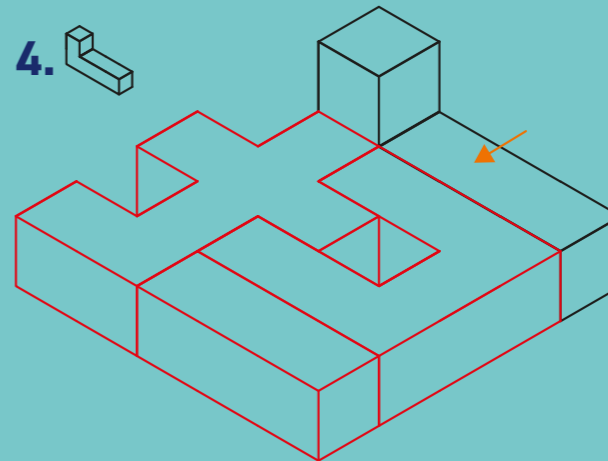

5.

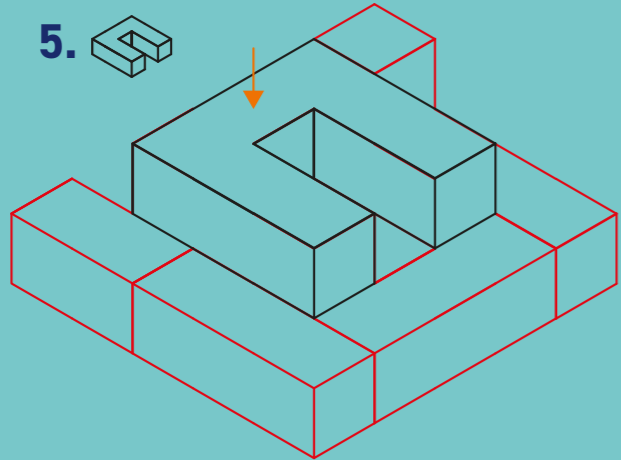

6.

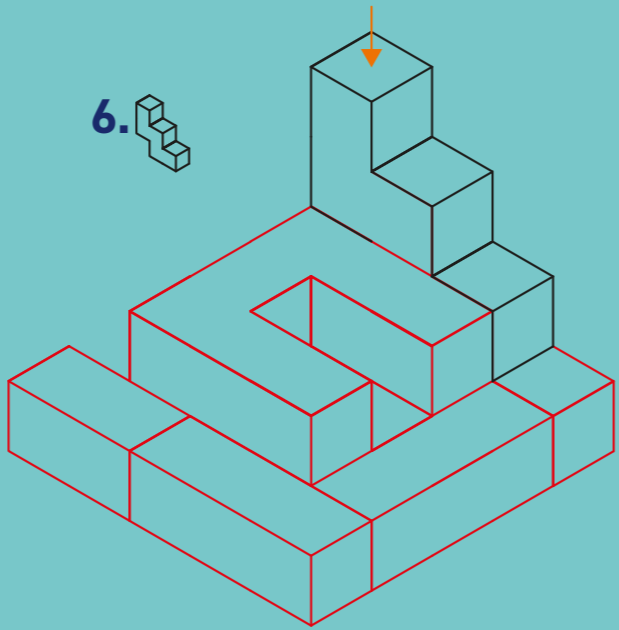

7.

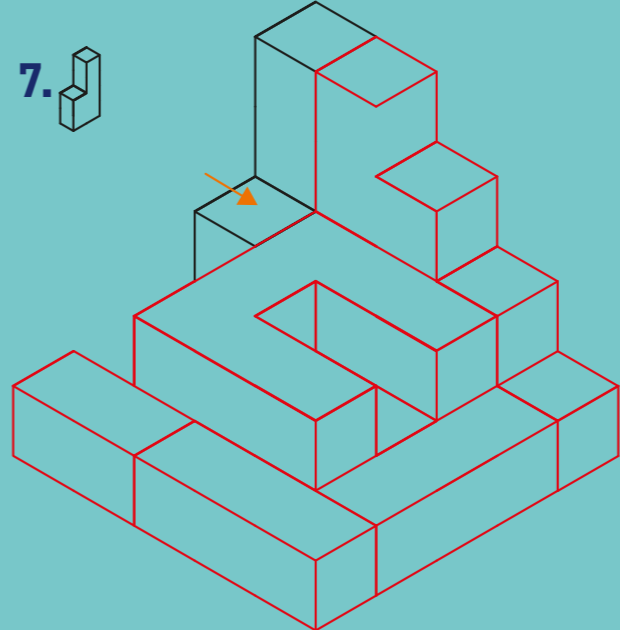

8.

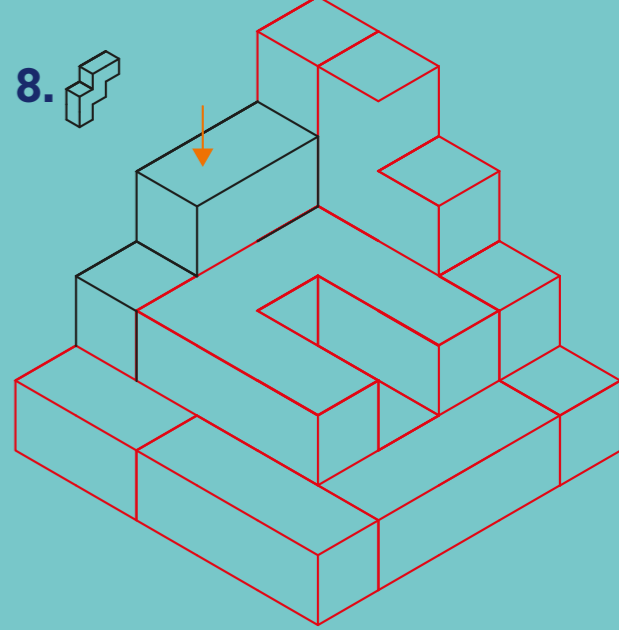

9.

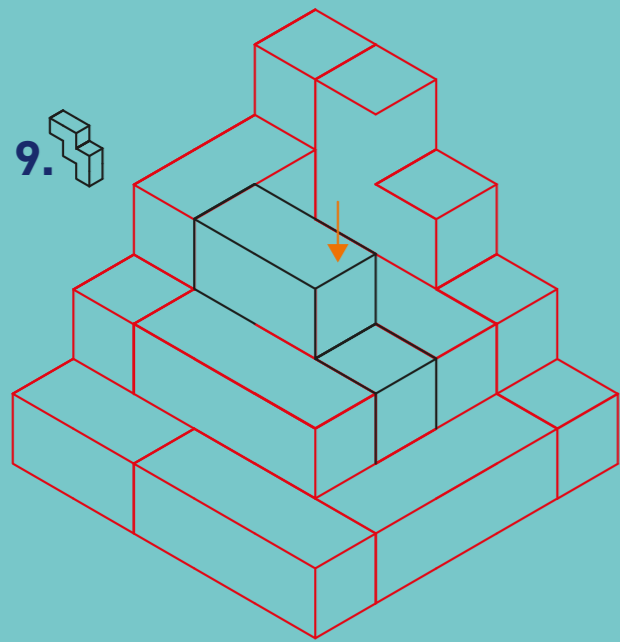

10.

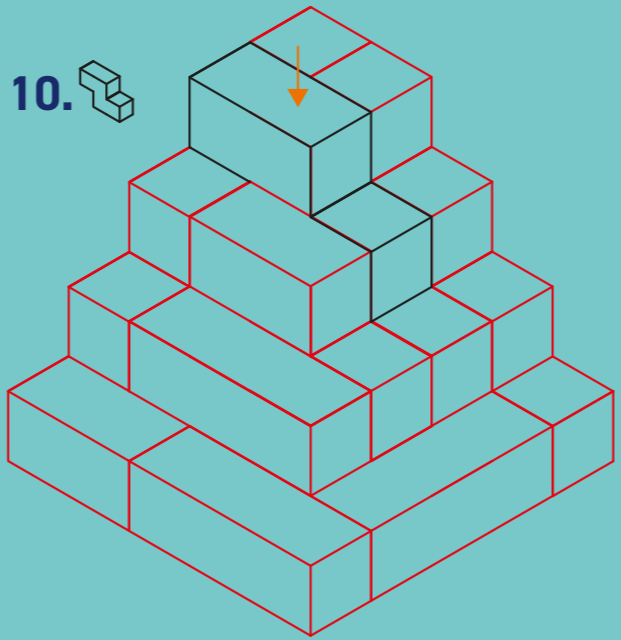

11.

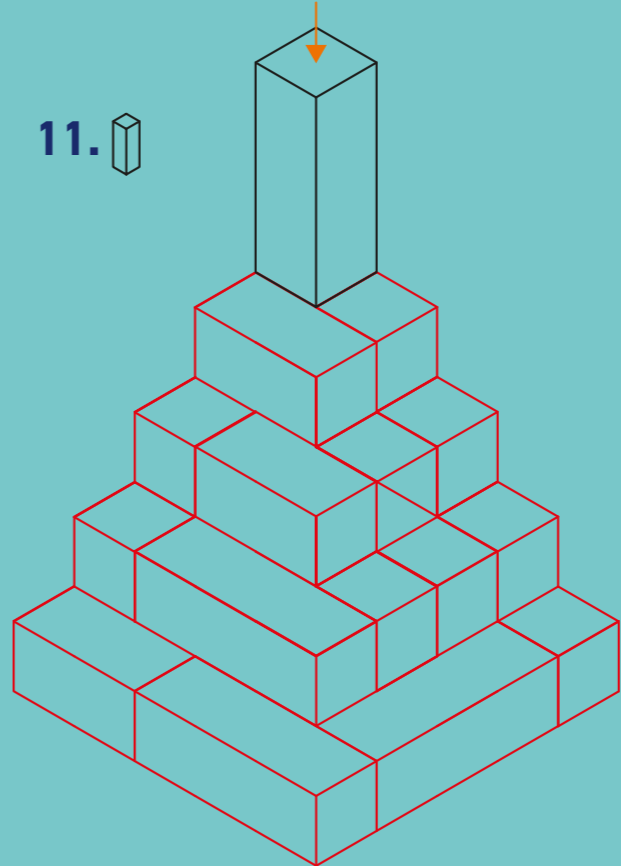

# THE QUANTUM QUERY

The hardest of them all!

Use all the letters to make a 4x4x5 cuboid.

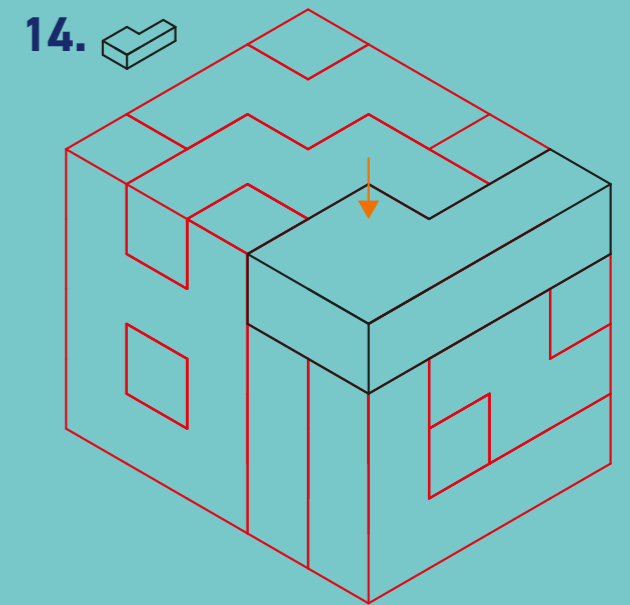
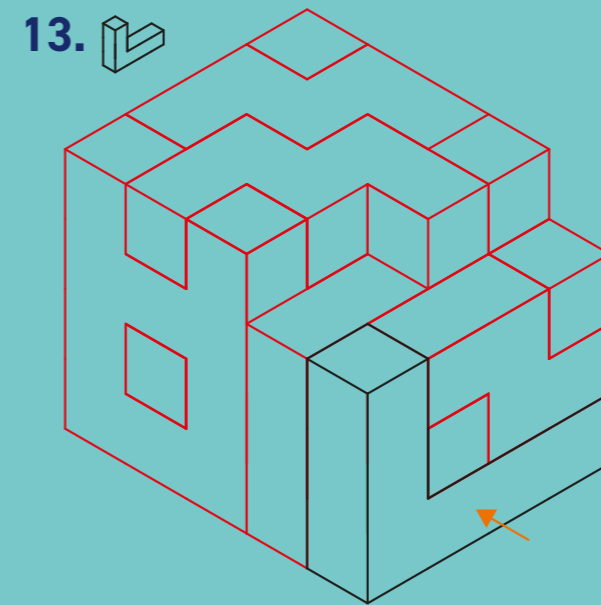
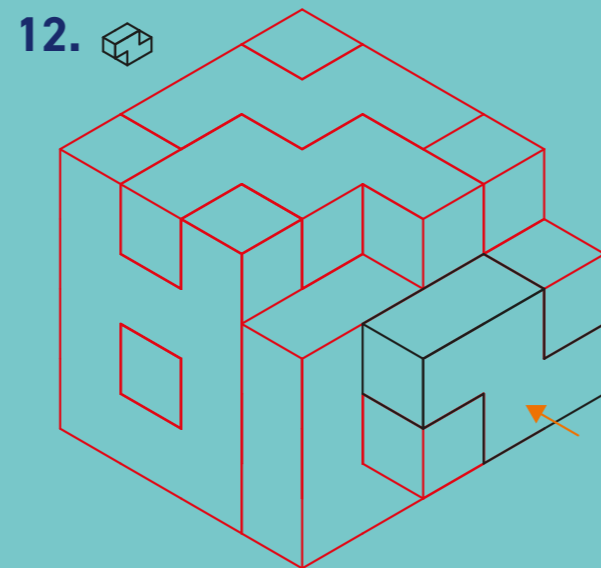
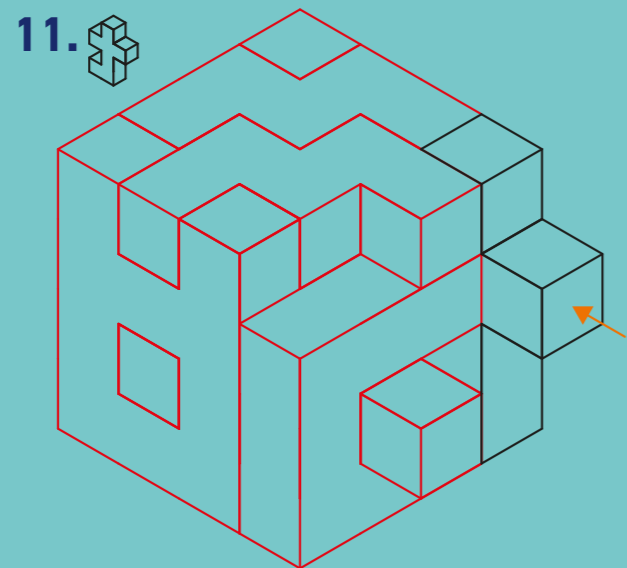
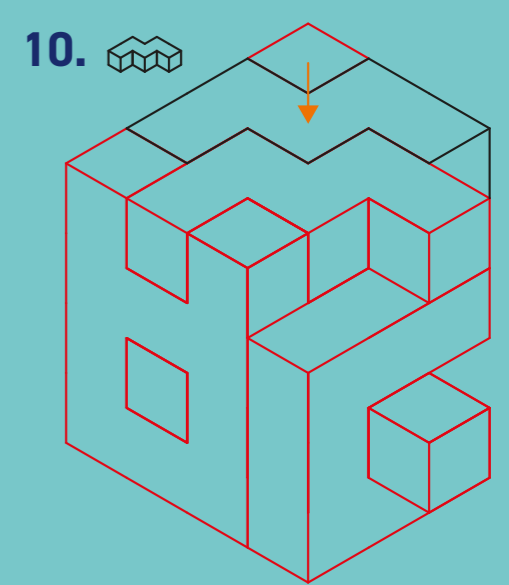
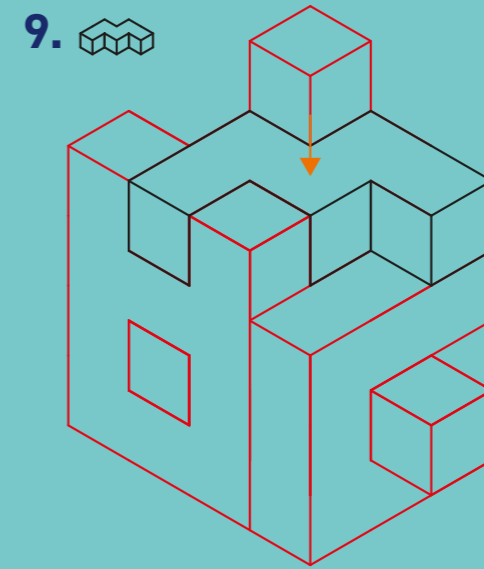
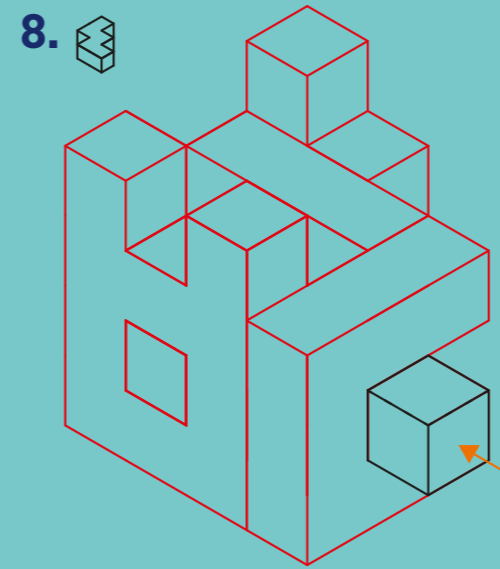
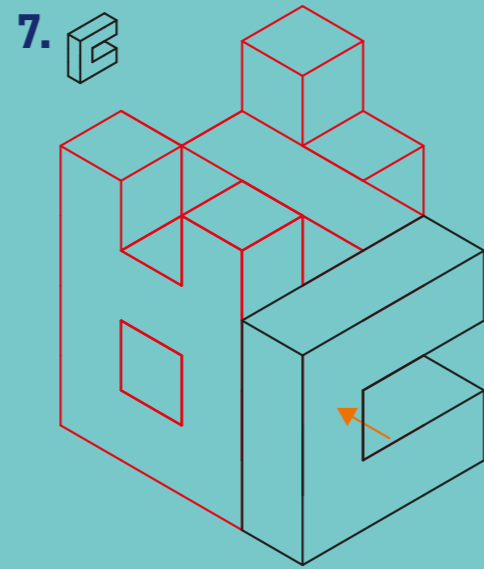
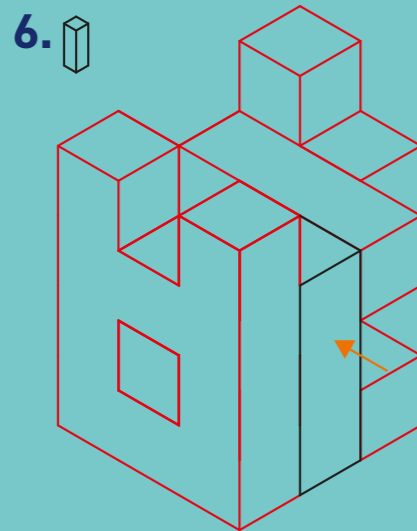
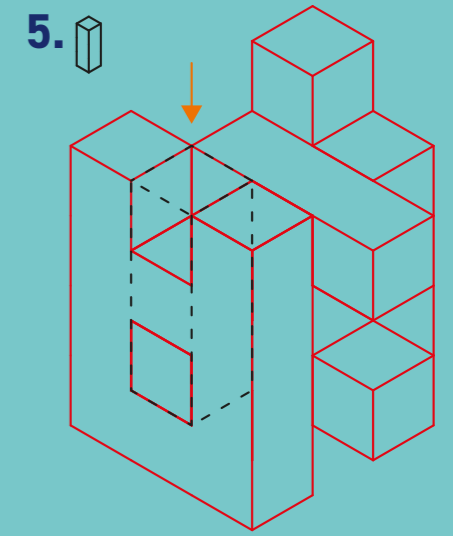
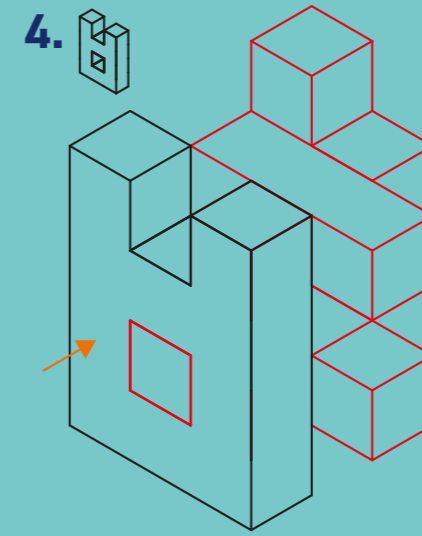
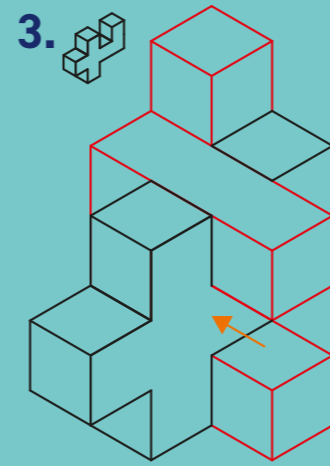
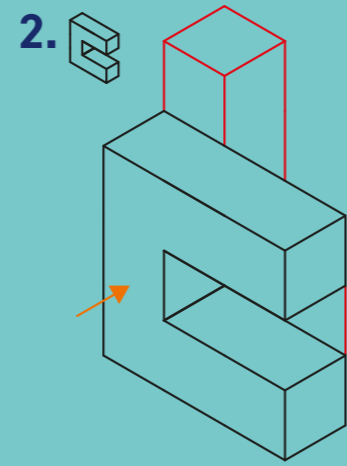
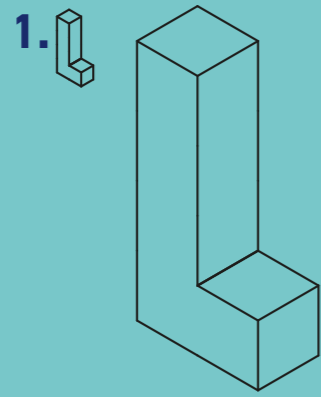

# THE RELATIVITY RIDDLE

Using all the letters can you make a square?

Please note that the space in the letter A will obviously remain empty and some letters could be upside-down.

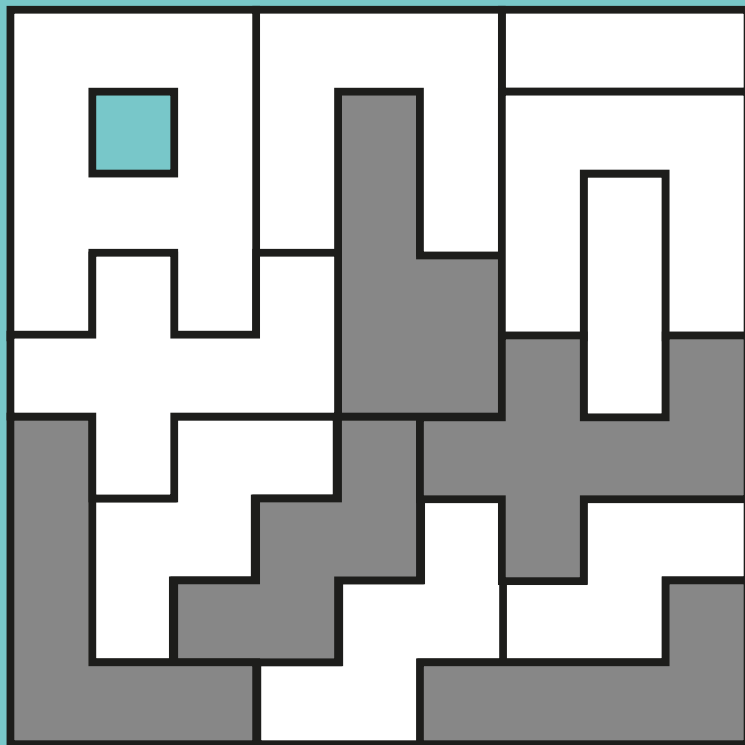
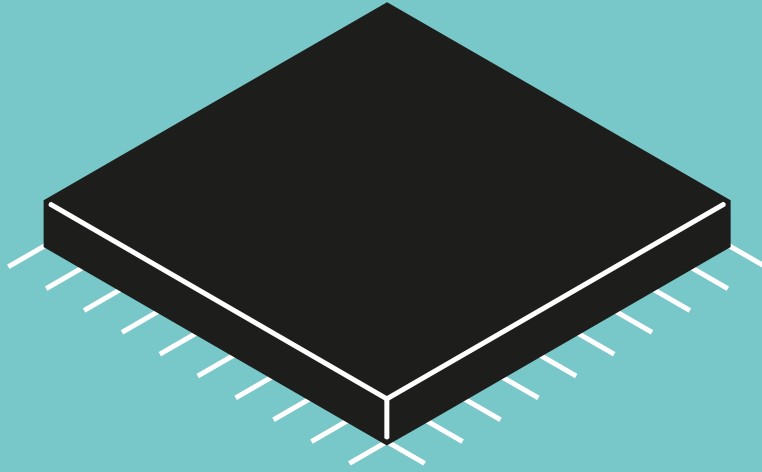

**ADDITIONAL CHALLENGES:** Can you use some of the letters to create the shapes in the diagrams below?

### SQUARES

5x5

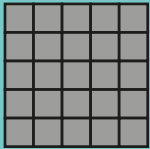

6x6

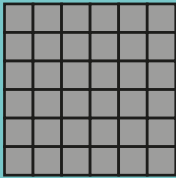

7x7

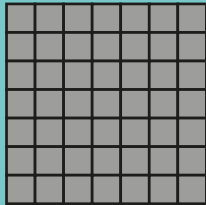

### RECTANGLES

3x7



3x8



3x9



3x10



3x11

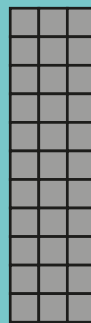

4x5

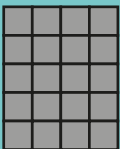

4x6

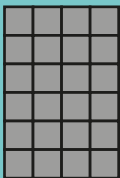

4x7

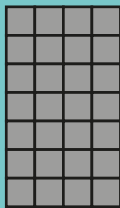

4x8

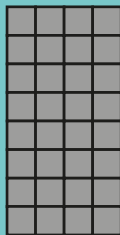

4x9

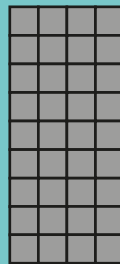

4x10

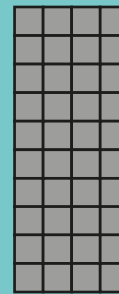

4x11

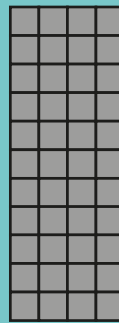

5x6

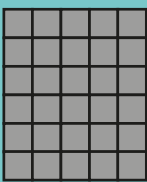

5x7

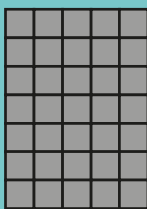

5x8

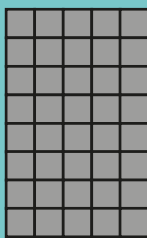

5x9

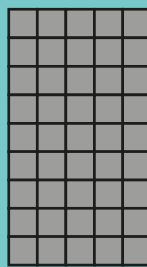

6x7

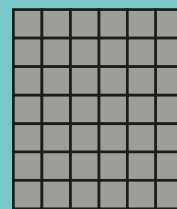

6x8

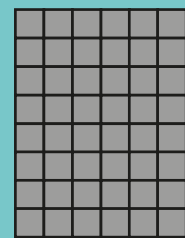

### OTHER SHAPES

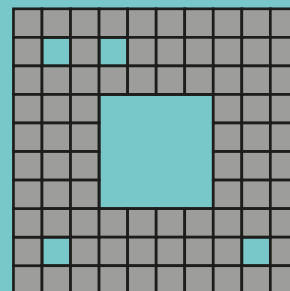
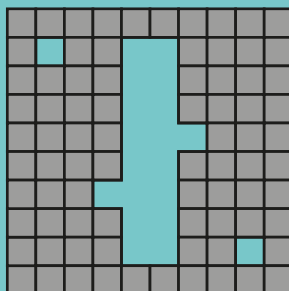
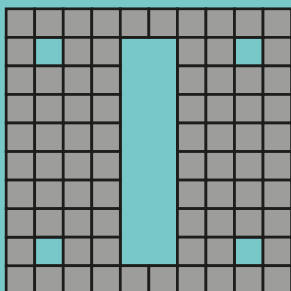

# ADDITIONAL CHALLENGES: SOLUTIONS

## SQUARES

5x5

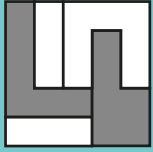

6x6

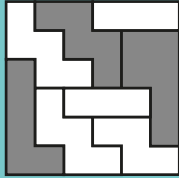

7x7

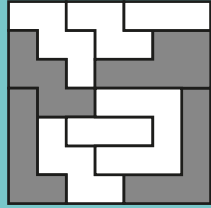

## RECTANGLES

3x7



3x8



3x9



3x10



3x11

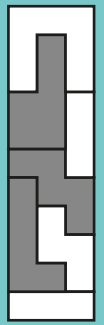

4x5

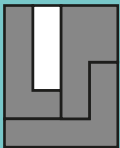

4x6

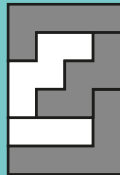

4x7

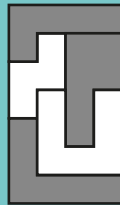

4x8

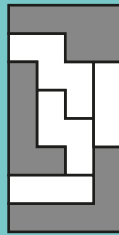

4x9



4x10

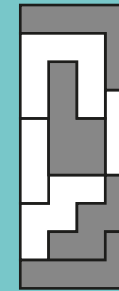

4x11

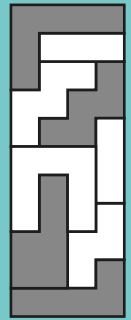

5x6

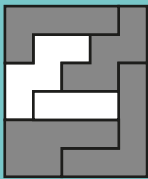

5x7

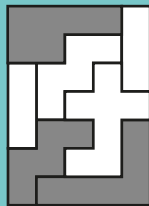

5x8

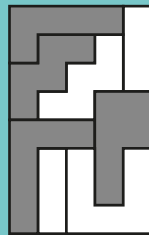

5x9

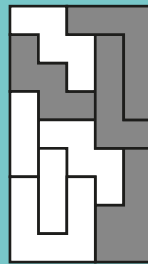

6x7

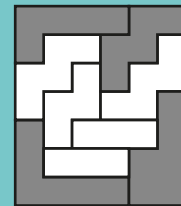

6x8

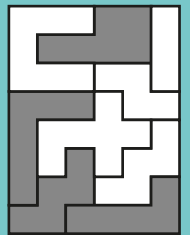

## OTHER SHAPES

